



Bravo

Espresso, Tea & Chocolate

The Art of Fresh Bean Espresso, Cappuccino, Tea, Chocolate, or Hot Beverages in a Countertop



Truly a barista... that *never* sleeps.

Bravo Espresso, Tea, & Chocolate... the Ultimate Experience

Bravo is a premium super-automatic bean-to-cup espresso and hot beverage machine that creates uplifting cafe-quality drinks with little effort and customization. The pleasure of specialty coffee should start with hassle-free creation and Bravo delivers. It is intended for medium-to-high demand locations that serve more than 250 cups of coffee per day, such as restaurants, offices, lounges, convenience stores, gas stations, and hotels.

Bravo's design will attract and impress consumers as it guides them through a pleasant experience. A perfect user experience is the culmination of years of research and development that sets Bravo apart from other super-automatic espresso machines.

















New Touchless Selection provides a user-friendly interface that anyone can operate without ever having to touch the screen to order. A 12-selection touchless screen is built inside a smoked glass door. Customize your menu with a large variety of drink decals according to your drink choices. Pre-selections such as "Start" and "Strengthen/Lessen Coffee" give the user control and options for a perfect drink every time.



Bravo caters to diverse tastes by delivering an impressive range of barista-style espresso, coffee, teas, and chocolate creations. Bravo makes specialty coffee drinks by grinding fresh coffee beans, tamping, extracting espresso, stirring and steaming real powdered milk from the canisters. Serve any espresso-based or instant drinks that taste good hot.

Bravo is a super-automatic espresso drink machine that's easy and quick to maintain, leaving you to focus on what's more important - your business. This attractive machine can be wrapped to inform the public and to increase sales. Use non-permanent magnets on the side panels, and the best promotional design grabs attention. The quality of the experience and consistently delicious drinks will keep customers coming back for more.

Bravo is constructed of quality noble materials, stainless steel and glass, for a contemporary premium look suited for customer-facing or any environment. Bravo provides consistent, high-quality espresso coffee service, which satisfies even the most demanding consumer tastes and is safe for public locations with no attendant.

-  Touchless Selection
-  Touch Screen
-  Sm Cup Holder
-  Espresso & Americano
-  Soluble
-  Single Bean
-  Secured Canisters
-  Removable Tray
-  LED
-  High Capacity
-  Cashless Payments
-  Hot water Spout
-  NAMA LISTED
-  SGS C US Certification*
-  ECO mode
-  Door Lock
-  USB & RS232 Connections

* Complying with UL Standard.



Drink Selection

Touchless Selection technology allows you to hover 1 cm away to order a drink for a hygienic approach.

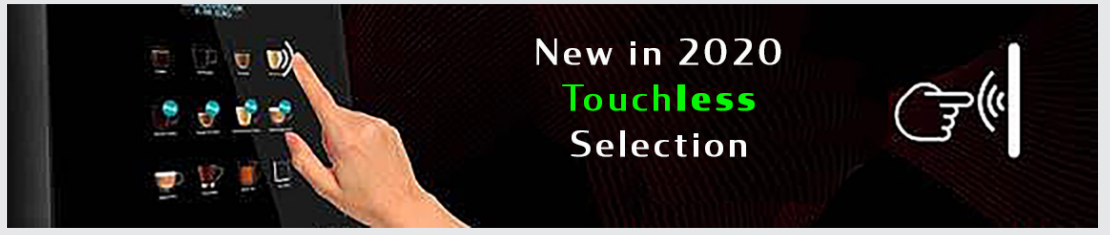

User-Friendly Ordering

12 button options give a vast array of popular drinks and pre-selections (see top row).

Bravo's back-lit decals represent popular recipes that are pre-configured in the system and are ready to be served.



Multiply Your Roast Choices

A whole-bean coffee hopper and grinder works with an adjustment lever for the grind point depending on the selected bean roast to obtain the best flavor and coffee notes in any and every brew.



A variable espresso brewer is pre-programmed to grind and dispense your chosen quantity of coffee grams. For each drink service, the consumer may adjust the coffee's intensity by 25% with the adjustment button to suit their taste.



Different Cup Sizes

The stainless steel dispensing area fits cups up to 5.5" (14 cm) tall between the spout and tray. It includes a retractable cup stand for small cups.

An optional cup sensor is available.

Automatic Cleaning

Designed to stay hygienic, auto-cleaning routines are quick and thorough with hot water. Schedule auto-cleaning at specific times throughout the day or night and minutes after each drink service.



Remote Control

A hand held remote gives instant access to the software program. Easily change drink configuration, check system functions, and one-button press for a cleaning cycle, etc.

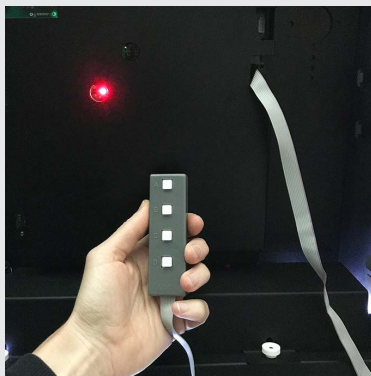

Easy to Refill Coffee & Soluble Ingredients

Filling the coffee bean hopper and soluble drink powders is quick and simple with Bravo's top-opening cabinet and flip-top canisters. There is no need to remove the canisters to reload.

Medium to High Autonomy

The coffee waste drawer has a high capacity - up to 220 coffee cakes.

The liquid waste tray holds .75 gallons and both trays are easily removed so daily maintenance is completed in little time. The tray is equipped with a "full capacity" sensor that prevents overflow by not allowing drink services when full. For high usage, add a base cabinet with larger waste bins.



Computer Control

Access Bravo's programming through a computer to quickly and easily change drink volume configuration, check timing, change your menu or canisters. Save files for access later.

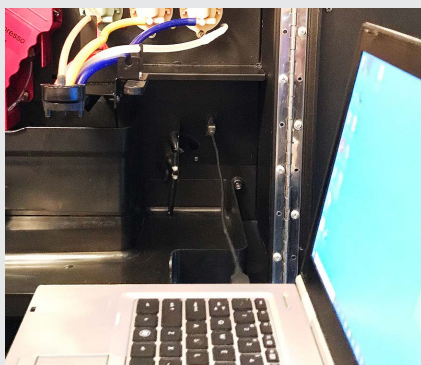

Accessories and Options

A complete range of accessories is available to adapt Bravo to any business model.

Bravo's accessories provide a distinctive service and help you improve on profitability.



Payments by Card or Contactless... Engage Your Customer, Promote Your Business

For a self-contained operation, Bravo works well with cashless payment systems. The MDB protocol and accessories allows Bravo to accept the latest payment methods to make all types of payments easy.

Nayax Payment System & Monyx App

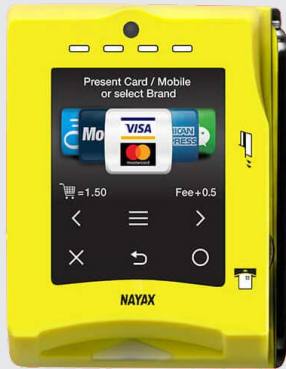

Nayax VPOS is an all-in-one card reader & telemetric terminal

- ✓ Accept all cashless payments and transmits data in real-time.
- ✓ Debit and Credit Cards
- ✓ Mobile and NFC Payments
- ✓ Prepaid cards and closed environment solutions
- ✓ Swipe, Contact
- ✓ Contactless
- ✓ QR codes

Cashless System Integration Holder

A housing box and cable so you can mount a cashless payment system.



Communication Kit

Provides a phone jack and board to add to a credit card reader and is a telemetry system to read data from the machine, such as number of drinks served.

Base Cabinet

Build a sturdy and elegant standalone solution. A self-contained water jug and pump allows for non-plumbed placement anywhere electricity is available.

A base cabinet provides an area for larger waste bins. Easily convert Bravo by removing the pre-cut floor openings.



Water Options

Use FlowJet's water pump and a BPA-free water gallon jug instead of plumbing Bravo's water from a city tap supply. Stores conveniently in the Base Cabinet.

FlowJet Pump BW5000 with 5-gallon stick



EnviroProducts BPA-Free Water Gallon



FlowJet BevJet Compact Pump

Bravo Espresso, Tea & Chocolate

Technical Specifications

TECHNICAL INFORMATION

DIMENSIONS

Brewing System	Espresso	
Capacity of Dispensing System	14 grams of coffee grounds per drink	
No. of Touchless Drink Selections	12	
No. of Coffee Bean Hoppers	1	
No. of Soluble Product Canisters	4	
Canister Capacity	Coffee bean hopper: 4.5 lb Milk & Chocolate: 5 lb Other solubles : 4.4 lb (tea, etc)	
No. of Mixing Bowls	3	
Grinder & Type	1-Flat steel burr blade	
Coffee Cakes Capacity	up to 220	
Boiler Type & Capacity	High Pressure	700 cc
Hot Water Spout	Yes	
Water Supply	Gallon & pump / 1/4" plumbed line	
Auto-cleaning	Functions with hot water after drink services. Can be scheduled.	
Liquids Tray Capacity	0.66 gal / 2.5 L	
Sensors and Filters	Out of coffee beans detector Blocked grinder detector Water temperature and water level control	
Connectivity	USB interface, EVA /DTS Standards, MDB	
Voltage / Frequency/ Maximum Power	110 V / 60 Hz /	1800 W
Payments, Cashless Reader	Optional Accessory	

Width : 18.9 in or 480 mm
Height : 30.5 in or 775 mm
Depth: 23.3 in or 590 mm
Weight: 121 lb or 55 kg

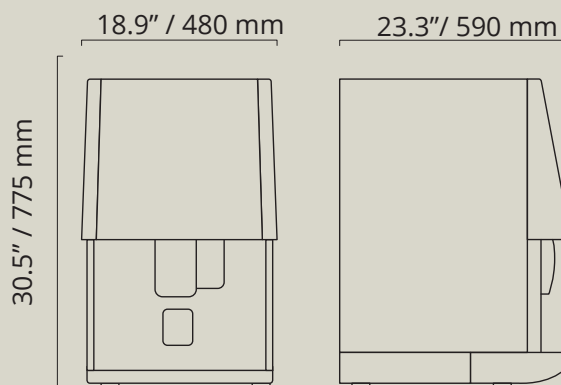

Base cabinet dimensions (Optional Accessory)
 Width 18.89" x Height 33.66" x Depth 23 1/4"
 Width 48 cm x Height 85.5 cm x Depth 59 cm



One-Touch Drinks
 PO Box 118300
 Carrollton, TX 75011-8300

(800) 560-5062
 info@onetouchdrinks.com
 onetouchdrinks.com